

Lamp housing PROLUMEN HC white IP20 (13914)

Product code: 13914
brand: [PROLUMEN](#)
IP rating: IP20
casing colour: white
casing material: plastic
polish: mat
working environment: indoor use

price: €10,00+VAT
price: €12,00 including VAT
Discount price: €8,33 + VAT



Motion detector HYTRONIK HC005S IP20 (14487)

Product code: 14487
brand: [HYTRONIK](#)
input voltage: 230V
IP rating: IP20
service life of LED: 50000h
height: 26mm
width: 36,5mm
length: 80mm
casing material: plastic
working environment: indoor use
working temperature: -35 - + 70°C
certifications: Semko, CB, CE, EMC, RED, SAA
warranty: 5 years

price: €17,50+VAT
price: €21,00 including VAT
Discount price: €15,00 + VAT

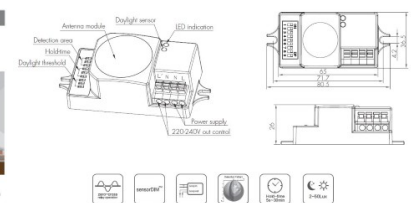
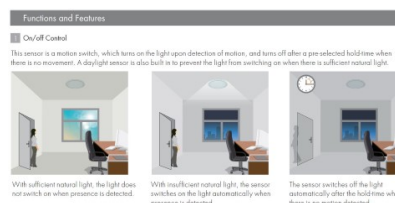
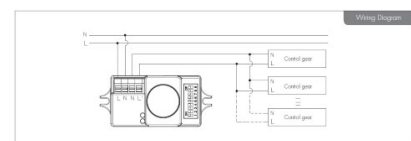

Motion detector THEBEN LUXA S180BK black IP55 (14339)

Product code: 14339
brand: [THEBEN](#)
input voltage: 230V
IP rating: IP55
casing colour: black
casing material: plastic
polish: mat
working temperature: -25 °C - +45°C
certifications: CE, RoHS
[manufacturers homepage](#)
warranty: 2 years

price: €24,17+VAT
price: €29,00 including VAT
Detection angle 180° Installation height 2 - 4 m
Light switch-off delay 1 s-20 min
Theben AG Hohenbergstr. 32 72401
Haigerloch GERMANY



Motion detector THEBEN LUXA S180WH white IP55 (14361)

Product code: 14361
 brand: [THEBEN](#)
 input voltage: 230V
 IP rating: IP55
 casing colour: white
 casing material: plastic
 working temperature: -25 °C - +45°C
 certifications: CE, RoHS
[manufacturers homepage](#)



price: €24,17+VAT
 price: €29,00 including VAT
 Detection angle 180° Installation height 2
 - 4 m Light switch-off delay 1 s-20 min
 Theben AG Hohenbergstr. 32 72401
 Haigerloch GERMANY

Motion detector HYTRONIK RF HC018V 0-10V (13913)

Product code: 13913
 brand: [HYTRONIK](#)
 input voltage: 230V
 casing material: plastic
 working environment: indoor use
 certifications: CE
[manufacturers homepage](#)
 warranty: 5 years

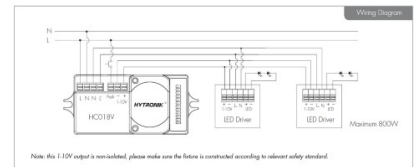

price: €35,83+VAT
 price: €43,00 including VAT
 Discount price: €29,17 + VAT
 1-10V output control to achieve tri-level
 dimming (corridor function), with manual
 override access

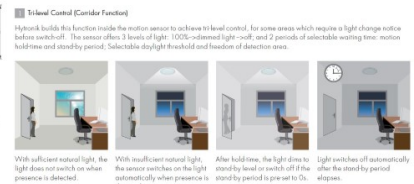
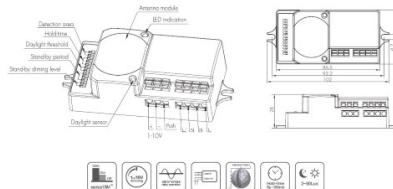

Motion detector PROLUMEN RF HC030S 800W IP20 (13911)

Product code: 13911
 brand: [PROLUMEN](#)
 input voltage: 230V
 power: 800W
 IP rating: IP20
 warranty: 5 years



price: €30,00+VAT
 price: €36,00 including VAT

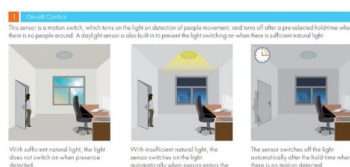
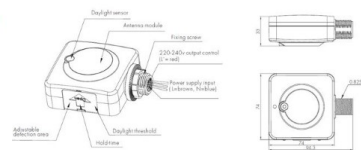

Motion detector PROLUMEN RF MC030S 12m 400W 150° IP20 (13897)

Product code: 13897
 brand: [PROLUMEN](#)
 input voltage: 230V
 power: 400W
 beam angle: 150°
 IP rating: IP20
 service life of LED: 50000h
 height: 25,5mm
 width: 36,5mm
 length: 75mm
 warranty: 2 years

price: €15,83+VAT
 price: €19,00 including VAT
 Inductive :400W, Resistive : 800W HF
 system 5.8GHz±75MHz, ISM wave band
 Power consumption ≤0.5W(standby),
 <1W(operation) Transmitting power
 <0.5mW Detection zone Max.(D x H) 12m
 x 6m Motion detection 0.5~3m/s
 Detection angle 150°(wall installation)
 360°(ceiling installation) Operation
 temperature -20°C~60°C Hold time 5s /
 30s / 90s / 3min / 20min / 30min
 Detection sensitivity 10% / 25% / 50% /
 75% / 100% Daylight sensor 2lux / 10lux /
 30lux / 50lux / Disable

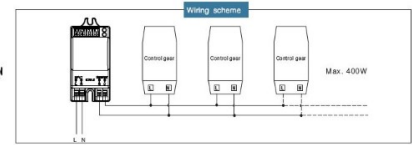
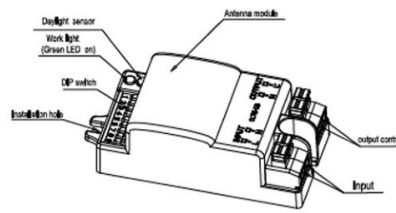

Motion detector Steinel STL-600419 black 500W 120° IP54 (14318)

Product code: 14318
 power: 500W
 beam angle: 120°
 IP rating: IP54
 casing colour: black
 casing material: plastic
 warranty: 2 years

price: €29,17+VAT
 price: €35,00 including VAT
 max 10m Time setting 8 sec. - 35 min.

