

## Ground light BLAKE 2 1xGU10 black 230V GU10 IP65

**Product code 18314**

Supply voltage 230V  
Socket GU10  
Protection class IP65  
In package 1pc  
In box 24pcs  
Casing colour black  
Casing material aluminium + plastic  
Work environment outdoor use  
Operation temperature -20 - +40°C  
Certificates CE  
Warranty 2 years



A durable and adjustable outdoor light, ideal for gardens, pathways, and facades. Its weather-resistant housing withstands moisture and dust, making it suitable for all kinds of weather conditions. The luminaire uses a replaceable light source and is easy to install thanks to the ground spike mount. An elegant and reliable solution for outdoor lighting

## Ground light Deko-Light Colt COB black 29W 2320lm 40° IP65 TRIAC 3000K warm white

**Product code 23013 TRIAC dimmable**

Brand [Deko-Light](#)

Dimmable TRIAC

Output 29W

Luminous flux 2320lumens

Luminaire's efficiency lm79 80W

Correlated colour temperature warm white 3000K

Lens angle 40

Protection class IP65

Lifespan 50000h

Width 120.0mm

Diameter 131.0mm

Casing colour black

Casing material metal + glass

No. of switches 15000pcs

Work environment outdoor use

Operation temperature -30 ~ 40°C

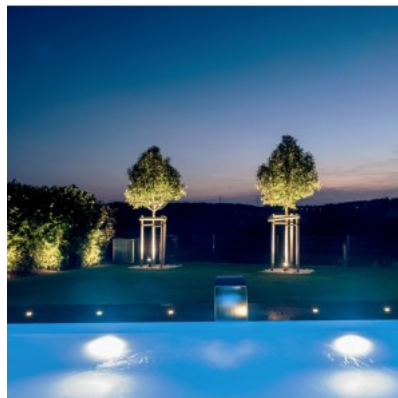
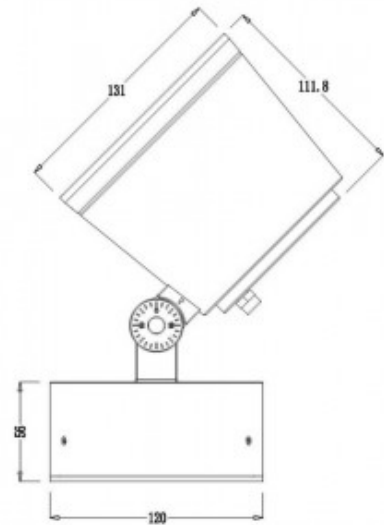

The COLT series is a genuine all-rounder outdoors: Powerful, freely rotatable and tiltable and equipped with the latest LED technology, the surface-mounted lamps deliver atmospheric illumination concepts in any outdoor application and cut a fine figure even when switched off thanks to their striking design.

**Ground light Deko-Light Colt COB Dim black 15W 1090lm 40° IP65 TRIAC 3000K warm white**

**Product code 20683 TRIAC dimmable**

Brand [Deko-Light](#)

Dimmable TRIAC

Output 15W

Luminous flux 1090lumens

Luminaire's efficiency lm79 73W

Correlated colour temperature warm white 3000K

Lens angle 40

Protection class IP65

Lifespan 50000h

Height 220.0mm

Length 88.0mm

Diameter 110.0mm

Casing colour black

Casing material metal + glass

No. of switches 15000pcs

Work environment outdoor use

Operation temperature -30 ~ 40°C



## Ground light Deko-Light Colt COB Dim black 7W 470lm 40° IP65 TRIAC 830

**Product code 20221 TRIAC dimmable**

Brand [Deko-Light](#)

Dimmable TRIAC

Output 7W

Luminous flux 470lumens

Luminaire's efficiency lm79 67W

Correlated colour temperature warm white 3000K

Lens angle 40

Cri 80

Protection class IP65

Lifespan 50000h

Height 185.0mm

Length 66.0mm

Weight 671 g

Package weight 912 g

Casing colour black

Casing material metal + glass

No. of switches 15000pcs

Operation temperature -30 ~ 40°C



## Reflector Deko-Light Colt silver 12°

**Product code 23014**

Brand [Deko-Light](#)

Lens angle 12

Height 53.0mm

Diameter 110.0mm

Casing colour silver

Casing material plastic



## Ground light Deko-Light Doradus 250 mm white E27 IP65

**Product code 20353**

Brand [Deko-Light](#)

Socket E27

Protection class IP65

Height 230.0mm

Diameter 250.0mm

Weight 795 g

Package weight 1.11 kg

Casing colour white

Casing material Polyethylene

Impact resistance IK07

Work environment outdoor use

Operation temperature -20 ~ 40°C

Warranty 5 years



## Ground light Deko-Light Doradus 380 mm white E27 IP65

**Product code 20355**

Brand [Deko-Light](#)

Socket E27

Protection class IP65

Height 350.0mm

Diameter 380.0mm

Weight 2.45 kg

Package weight 3.18 kg

Casing colour white

Casing material Polyethylene

Impact resistance IK07

Work environment outdoor use

Operation temperature -20 ~ 40°C

Warranty 5 years

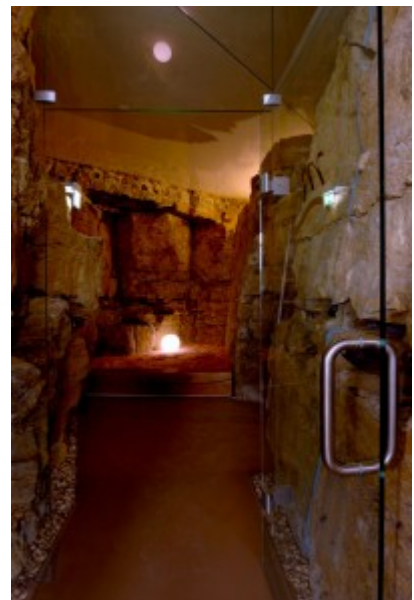

## Ground light Deko-Light Doradus 450 mm white E27 IP65

**Product code 20354**

Brand [Deko-Light](#)

Socket E27

Protection class IP65

Height 420.0mm

Diameter 450.0mm

Weight 2.95 kg

Package weight 3.9 kg

Casing colour white

Casing material Polyethylene

Impact resistance IK07

Work environment outdoor use

Operation temperature -20 ~ 40°C

Warranty 5 years



## Ground light Deko-Light Doradus 560 mm white E27 IP65

**Product code 20356**

Brand [Deko-Light](#)

Socket E27

Sdcm - macadam ellipses 7

Protection class IP65

Height 530.0mm

Diameter 560.0mm

Weight 4.3 kg

Package weight 5.98 kg

Casing colour white

Casing material Polyethylene

Impact resistance IK07

Work environment indoor / outdoor  
use

Operation temperature -20 ~ 40°C

Warranty 5 years

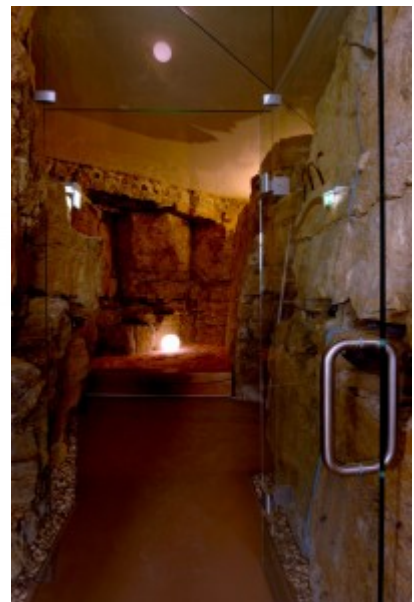

## Ground light Deko-Light Keid II gray 10.3W 800lm IP65 830

**Product code 20320**

Brand [Deko-Light](#)

Output 10.3W

Luminous flux 800lumens

Luminaire's efficiency lm79 78W

Correlated colour temperature warm white 3000K

Cri 80

Protection class IP65

Lifespan 30000h

Height 457.0mm

Length 120.0mm

Weight 833 g

Package weight 1.07 kg

Casing colour gray

Casing material metal + glass

No. of switches 25000pcs

Operation temperature -20 ~ 40°C



## Ground light Deko-Light Keid II gray 21.5W 1350lm IP65 830

**Product code 20321**

Brand [Deko-Light](#)

Output 21.5W

Luminous flux 1350lumens

Luminaire's efficiency lm79 63W

Correlated colour temperature warm white 3000K

Cri 80

Protection class IP65

Lifespan 30000h

Height 457.0mm

Length 120.0mm

Weight 1.01 kg

Package weight 1.25 kg

Casing colour gray

Casing material metal + glass

No. of switches 25000pcs

Operation temperature -20 ~ 40°C



## Ground light Deko-Light Spiky black GU10 IP65

**Product code 20352**

Brand [Deko-Light](#)

Socket GU10

Sdcm - macadam ellipses 5

Protection class IP65

Height 345.0mm

Diameter 100.0mm

Weight 732 g

Package weight 792 g

Casing colour black

Operation temperature -10 ~ 45°C



## Ground light Deko-Light Spiky gray GU10 IP65

**Product code 20351**

Brand [Deko-Light](#)

Socket GU10

Sdcm - macadam ellipses 5

Protection class IP65

Height 420.0mm

Diameter 60.0mm

Weight 651 g

Package weight 719 g

Casing colour gray

Operation temperature -10 ~ 45°C



## Ground light Kobi Garden ball gray E27 IP65

**Product code 22509**

Brand Kobi  
 Maximum output 40W/1m  
 Socket E27  
 Protection class IP65  
 Height 350.0mm  
 Diameter 380.0mm  
 Package weight 1.76 kg  
 Casing colour gray  
 Casing material Polyethylene  
 Impact resistance IK02  
 Operation temperature -20 ~ 40°C  
 Warranty 2 years



## Ground light Maytoni Bern graphite 15W 1200lm 55° IP65 830

**Product code 19742**

Brand Maytoni  
 Output 15W  
 Luminous flux 1200lumens  
 Luminaire's efficiency lm79 80W  
 Correlated colour temperature warm white 3000K  
 Lens angle 55  
 Cri 80  
 Protection class IP65  
 Length 168.0mm  
 Casing colour graphite  
 Casing material aluminium  
 Work environment outdoor use



## Ground light Maytoni Bern graphite 30W 2800lm 50° IP65 830

### Product code 19744

Brand Maytoni  
Output 30W  
Luminous flux 2800lumens  
Luminaire's efficiency lm79 93W  
Correlated colour temperature warm white 3000K  
Lens angle 50  
Cri 80  
Protection class IP65  
Length 230.0mm  
Casing colour graphite  
Casing material aluminium  
Work environment outdoor use



## Ground light Maytoni Bern graphite 5W 280lm 65° IP65 830

### Product code 19746

Brand Maytoni  
Output 5W  
Luminous flux 280lumens  
Luminaire's efficiency lm79 56W  
Correlated colour temperature warm white 3000K  
Lens angle 65  
Cri 80  
Protection class IP65  
Length 117.0mm  
Casing colour graphite  
Casing material aluminium  
Work environment outdoor use



## Ground light Maytoni Bern white 15W 1200lm 55° IP65 830

**Product code 19743**

Brand Maytoni  
Output 15W  
Luminous flux 1200lumens  
Luminaire's efficiency lm79 80W  
Correlated colour temperature warm  
white 3000K  
Lens angle 55  
Cri 80  
Protection class IP65  
Length 168.0mm  
Diameter 108.0mm  
Weight 910 g  
Package weight 1.09 kg  
Casing colour white  
Casing material aluminium  
Work environment outdoor use  
Operation temperature -40...+50°C  
Warranty 3 years



## Ground light Maytoni Bern white 30W 2800lm 50° IP65 830

**Product code 19745**

Brand Maytoni  
Output 30W  
Luminous flux 2800lumens  
Luminaire's efficiency lm79 93W  
Correlated colour temperature warm  
white 3000K  
Lens angle 50  
Cri 80  
Protection class IP65  
Length 230.0mm  
Casing colour white  
Casing material aluminium  
Work environment outdoor use



## Ground light Maytoni Bern white 5W 300lm 65° IP65 830

### Product code 19747

Brand Maytoni  
Output 5W  
Luminous flux 300lumens  
Luminaire's efficiency lm79 60W  
Correlated colour temperature warm  
white 3000K  
Lens angle 65  
Cri 80  
Protection class IP65  
Length 117.0mm  
Casing colour white  
Casing material aluminium  
Work environment outdoor use



## Ground light Maytoni Core black 25W 1850lm 36° IP65 830

### Product code 22155

Brand Maytoni  
Output 25W  
Luminous flux 1850lumens  
Luminaire's efficiency lm79 74W  
Correlated colour temperature warm  
white 3000K  
Lens angle 36  
Cri 80  
Protection class IP65  
Height 356.0mm  
Width 104.0mm  
Casing colour black  
Casing material aluminium  
Work environment outdoor use  
Warranty 3 years



## Ground light Maytoni Erda D 50 cm white 30W E27 IP54

### Product code 19781

Brand Maytoni  
Output 30W  
Socket E27  
Protection class IP54  
Height 490.0mm  
Width 500.0mm  
Length 500.0mm  
Weight 2.31 kg  
Package weight 3.7 kg  
Casing colour white  
Casing material plastic  
Work environment outdoor use  
Operation temperature -40...+50°C°C



## Ground light Maytoni Erda D30 cm white 30W E27 IP54

### Product code 19780

Brand Maytoni  
Output 30W  
Socket E27  
Protection class IP54  
Height 290.0mm  
Width 300.0mm  
Length 300.0mm  
Weight 940 g  
Package weight 1.5 kg  
Casing colour white  
Casing material plastic  
Work environment outdoor use



## Ground light Maytoni Scope black GU10 IP65

**Product code 19911**

Brand Maytoni  
 Socket GU10  
 Protection class IP65  
 Height 295.0mm  
 Width 95.0mm  
 Weight 340 g  
 Package weight 380 g  
 Casing colour black  
 Casing material aluminium  
 Work environment outdoor use  
 Operation temperature -40...+50°C°C  
 Warranty 2 years



## Ground light Prolumen ML07 black 12V 10W 800lm 36° IP65 830

**Product code 15277**

Brand [Prolumen](#)  
 Supply voltage 12V  
 Output 10W  
 Maximum output 10W/1m  
 Luminous flux 800lumens  
 Luminaire's efficiency lm79 80W  
 Correlated colour temperature warm  
 white 3000K  
 Lens angle 36  
 Cri 80  
 Protection class IP65  
 Lifespan 40000h  
 Height 262.0mm  
 Width 56.0mm  
 Diameter 76.0mm  
 Weight 300 g  
 Package weight 50 g  
 In package 1pc  
 In box 50pcs  
 Casing colour black  
 Casing material aluminium  
 Work environment outdoor use  
 Certificates CE  
 Warranty 5 years



LED garden light, stake-mounted.

## **Ground light Prolumen oculus black 12V 10W 800lm CRI90 60° IP65**

**Product code 20690**

---

Brand [Prolumen](#)

Supply voltage 12V

Output 10W

Maximum output 10W/1m

Luminous flux 800lumens

Luminaire's efficiency lm79 80W

Lens angle 60

Cri 90

Protection class IP65

Length 100.0mm

Diameter 76.0mm

In package 1pc

In box 50pcs

Casing colour black

Casing material aluminium + plastic

Work environment outdoor use

Operation temperature -20 - +40°C

Certificates CE

Warranty 2 years



## **Ground light Trio Lighting Bolo E27 IP44**

**Product code 19496**Brand [Trio Lighting](#)

Socket E27

Protection class IP44

Diameter 400.0mm

Casing material plastic

Work environment outdoor use

Inviting and effective - outdoor lights set atmospheric lighting accents around the house. The decorative BOLO garden ground light has a five metre supply cable and is supplied with a ground spike so that you can easily fix it in your garden. The globe light has a diameter of 40 cm and is extremely weather-resistant thanks to its IP44 rating. The light conjures up a harmonious atmosphere in your outdoor area or brings it safely to the house or garage as a path light. The BOLO garden light comes with a white plastic globe and a black ground spike. For energy-saving lighting, it is recommended to use an LED illuminant. These are an optimal alternative to conventional halogen lamps and stand for a high quality of light and energy savings of up to 80%. In addition, LED lamps help you benefit from a long service life, low heat generation and at the same time protect the environment.



## Ground light Trio Lighting Bolo E27 IP44

**Product code 19527**

Brand [Trio Lighting](#)

Socket E27

Protection class IP44

Diameter 200.0mm

Weight 800 g

Package weight 1 kg

Casing material plastic

Work environment outdoor use

Inviting and effective - outdoor lights set atmospheric lighting accents around the house. The decorative BOLO garden ground light has a five metre supply cable and is supplied with a ground spike so that you can easily fix it in your garden. The globe light has a diameter of 40 cm and is extremely weather-resistant thanks to its IP44 rating. The light conjures up a harmonious atmosphere in your outdoor area or brings it safely to the house or garage as a path light. The BOLO garden light comes with a white plastic globe and a black ground spike. For energy-saving lighting, it is recommended to use an LED illuminant. These are an optimal alternative to conventional halogen lamps and stand for a high quality of light and energy savings of up to 80%. In addition, LED lamps help you benefit from a long service life, low heat generation and at the same time protect the environment.

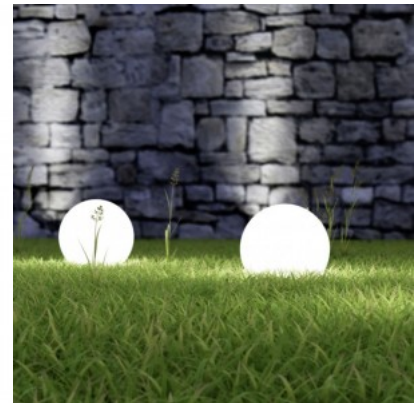

## Ground light Trio Lighting Caceres anthracite round E27 IP44

**Product code 20705**

Brand [Trio Lighting](#)  
Socket E27  
Protection class IP44  
Height 51.0mm  
Diameter 12.5mm  
Casing colour anthracite  
Casing material aluminium  
Shape round

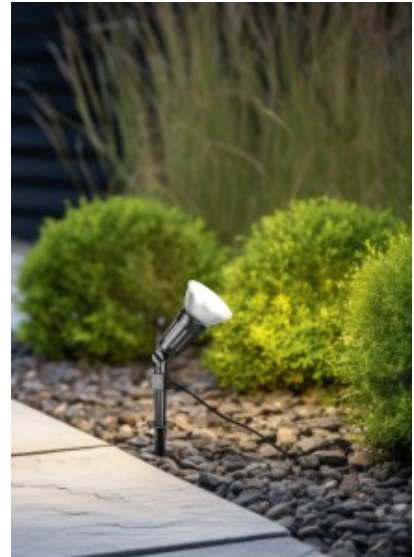

## Garden light Trio Lighting Jamaica white 2,5W 25lm IP44 RGB + 3000K RGBW warm

**Product code 22967**

Brand [Trio Lighting](#)

Output 2,5W

Maximum output 2.5W/1m

Luminous flux 25lumens

Correlated colour temperature RGBW

warm RGB + 3000K

Protection class IP44

Lifespan 50000h

Height 380.0mm

Diameter 245.0mm

Weight 2.1 kg

Package weight 2.5 kg

Casing colour white

Casing material plastic

No. of switches 50000pcs

Work environment indoor / outdoor  
use

Warranty 5 years

Innovative mood maker. The JAMAICA is a table lamp, Bluetooth speaker and drinks cooler in one. Create relaxed ambient lighting with the integrated RGBW colour changer for long summer evenings on the balcony or terrace. Thanks to its stylish design, the JAMAICA not only impresses with its high functionality but also as a decorative and design object. The JAMAICA is battery-operated and can therefore be used indoors and outdoors. When fully charged, the battery lasts up to 10 hours. The loudspeaker is controlled via the Bluetooth connection with mobile devices, and light settings can be conveniently controlled using the remote control supplied. The white plastic design optimally reflects the light and is rounded off with a decorative brown band as a handle. In addition, the luminaire features modern LED technology, which is characterised by high light quality and energy efficiency. Compared to conventional halogen lamps, up to 80% of energy costs can be saved. In addition, LED light sources have a long service life, produce less heat and protect the environment.



## Ground light Trio Lighting Melo 20cm white 5W 30lm IP67 RGB + 3000K RGBW warm

**Product code 19465**

Brand [Trio Lighting](#)

Output 5W

Luminous flux 30lumens

Luminaire's efficiency lm79 6W

Correlated colour temperature RGBW warm RGB + 3000K

Protection class IP67

Height 174.0mm

Diameter 200.0mm

Casing colour white

Casing material plastic

Work environment outdoor use

Solar lights use only the power of the sun to generate light. They are a practical solution for outdoor areas, as they do not require sockets or a connection to the mains. Combined with modern LED technology, solar lights provide ideal lighting for your home and garden. Simply place the light where light is needed. The round MELO solar light creates an atmospheric ambience and inviting lighting accents around the house thanks to its integrated RGBW colour changer. It is controlled via a switch on the light and the included remote control. With an IP65 protection rating, the light is dustproof and protected against water jets. The solar light has a burn time of 6 hours and a charging time of approx. 8 hours. The neutral design in white, allows an easy integration into your garden and sets additional modern accents.

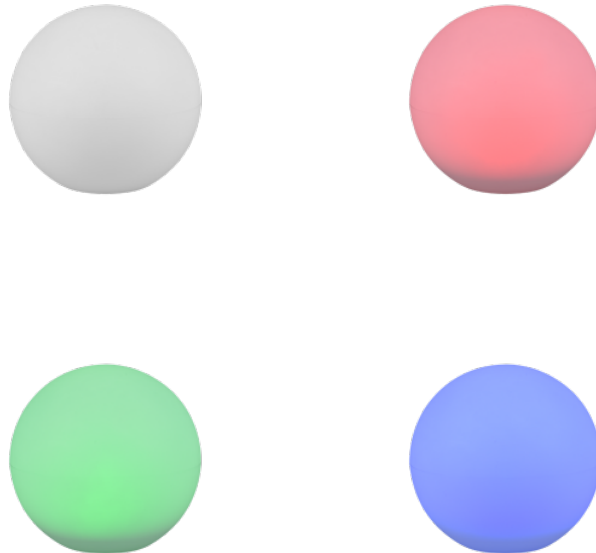

## Ground light Trio Lighting Melo 30 cm päikesepatareiga white 0,5W 30lm IP67 RGB + 3000K RGBW warm

**Product code 19541**

Brand [Trio Lighting](#)

Output 0,5W

Maximum output 0.5W/1m

Luminous flux 30lumens

Correlated colour temperature RGBW

warm RGB + 3000K

Protection class IP67

Lifespan 20000h

Diameter 280.0mm

Casing colour white

Casing material plastic

No. of switches 10000pcs

Work environment indoor use

Warranty 5 years

Solar lights use only the power of the sun to generate light. They are a practical solution for outdoor areas, as they do not require sockets or a connection to the mains. Combined with modern LED technology, solar lights provide ideal lighting for your home and garden. Simply place the light where light is needed. The round MELO solar light creates an atmospheric ambience and inviting lighting accents around the house thanks to its integrated RGBW colour changer. It is controlled via a switch on the light and the included remote control. With an IP65 protection rating, the light is dustproof and protected against water jets. The solar light has a burn time of 6 hours and a charging time of approx. 8 hours. The neutral design in white, allows an easy integration into your garden and sets additional modern accents.

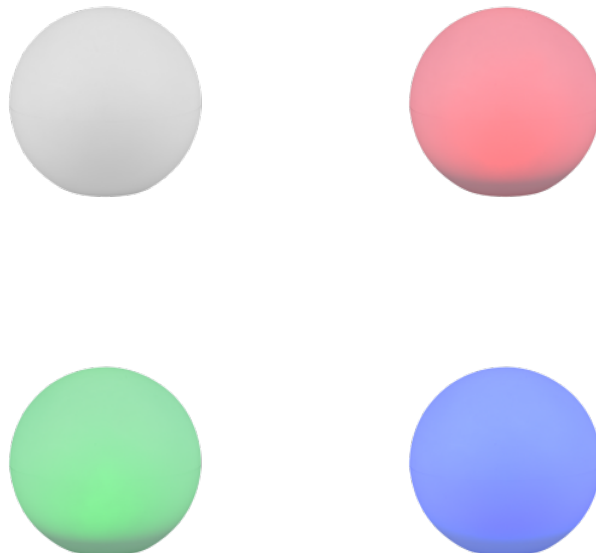

## Ground light Trio Lighting Ubangi 3 X GU10 anthracite round GU10

**Product code 19426**

Brand [Trio Lighting](#)

Socket GU10

Height 110.0mm

Diameter 90.0mm

Casing colour anthracite

Casing material aluminium

Shape round

Inviting and effective - the UBANGI outdoor lights set atmospheric lighting accents around the house. The decorative set of three has a five metre long supply cable and three metre long cable connections between each spotlight. Each spotlight has a ground spike so that they can be positioned flexibly and easily in your garden. Each spotlight has a diameter of approx. 9 cm and is extremely weather-resistant thanks to its IP65 protection rating. Thanks to the discreet anthracite colour scheme, the outdoor lights can be stylishly integrated into a variety of garden concepts. For modern and reliable lighting, the use of an LED bulb is recommended. It offers a high quality of light, is versatile and convinces with uniform illumination. Its long service life and low heat generation make it the ideal choice for a wide range of applications.

